

Description

DLLC05I-HI a 5V uni-directional TVS diode, utilizing leading monolithic silicon technology to provide fast response time and low ESD clamping voltage, making this device an ideal solution for protecting voltage sensitive high-speed data lines. The DLLC05I-HI has a low capacitance with a typical value at 1.5pF, and complies with the IEC 61000-4-2 (ESD) standard with $\pm 30\text{kV}$ air and $\pm 30\text{kV}$ contact discharge. It is assembled into a lead-free SOD-323 package. The small size, low capacitance and high ESD surge protection make DLLC05I-HI an ideal choice to protect cellphone, wireless systems, and communication equipment.

Features

- ◆ Ultra low capacitance : 1.5pF typical
- ◆ Ultra low leakage: nA level
- ◆ Low Operating: 5V
- ◆ Low clamping voltage
- ◆ Protects one power line or data line
- ◆ Complies with following standards:
 - IEC 61000-4-2 (ESD) immunity test
Air discharge: $\pm 30\text{kV}$
Contact discharge: $\pm 30\text{kV}$
 - IEC61000-4-4 (EFT) 40A (5/50ns)
- ◆ RoHS Compliant

Mechanical Characteristics

- ◆ Package: SOD-323
- ◆ Lead Finish: Matte Tin
- ◆ Case Material: “Green” Molding Compound.
- ◆ UL Flammability Classification Rating 94V-0
- ◆ Moisture Sensitivity: Level 3 per J-STD-020
- ◆ Terminal Connections: See Diagram Below
- ◆ Marking Information: See Below

Applications

- ◆ USB Ports
- ◆ Smart Phones
- ◆ Wireless Systems
- ◆ Ethernet 10/100/1000 Base T

Dimensions and Pin Configuration

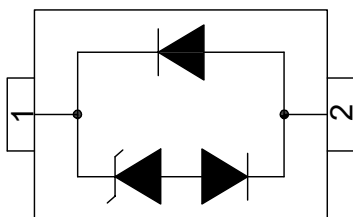

Circuit and Pin Schematic

Marking Information

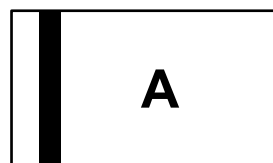

A = Device Marking Code

Ordering Information

Part Number	Marking	Packaging	Reel Size
DLLC05I-HI	A	3000/Tape & Reel	7 inch

Absolute Maximum Ratings ($T_A=25^{\circ}\text{C}$ unless otherwise specified)

Parameter	Symbol	Value	Unit
Peak Pulse Power (8/20 μs)	Ppk	550	W
Peak Pulse Current (8/20 μs)	IPP	30	A
ESD per IEC 61000-4-2 (Air) ESD per IEC 61000-4-2 (Contact)	VESD	± 30 ± 30	kV
Operating Temperature Range	TJ	-55 to +125	$^{\circ}\text{C}$
Storage Temperature Range	Tstg	-55 to +150	$^{\circ}\text{C}$

Electrical Characteristics ($T_A=25^{\circ}\text{C}$ unless otherwise specified)

Parameter	Symbol	Min	Typ	Max	Unit	Test Condition
Reverse Working Voltage	VRWM			5	V	
Breakdown Voltage	VBR	6			V	$I_T = 1\text{mA}$
Reverse Leakage Current	I_R			100	nA	$VRWM = 5\text{V}$
Clamping Voltage	VC		8.5	10	V	$IPP = 1\text{A}$ (8 x 20 μs pulse)
Clamping Voltage	VC		18	25	V	$IPP = 30\text{A}$ (8 x 20 μs pulse)
Junction Capacitance	CJ		1.2	2	pF	$VR = 0\text{V}$, $f = 1\text{MHz}$

Typical Performance Characteristics (TA=25°C unless otherwise Specified)

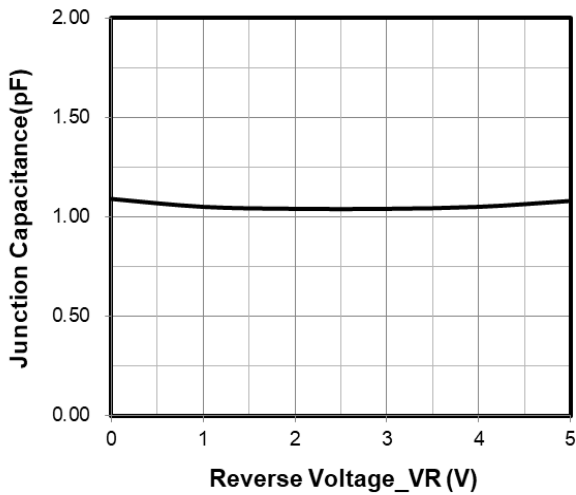

Junction Capacitance vs. Reverse Voltage

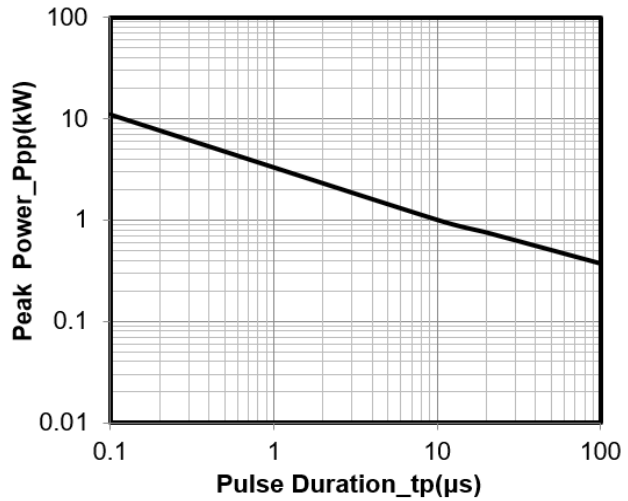

Peak Pulse Power vs. Pulse Time

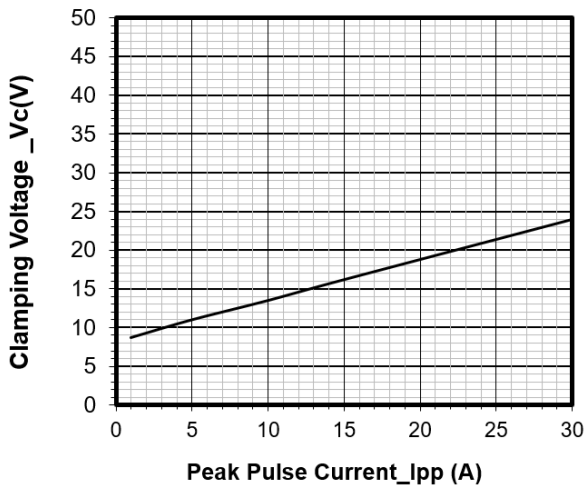

Clamping Voltage vs. Peak Pulse Current

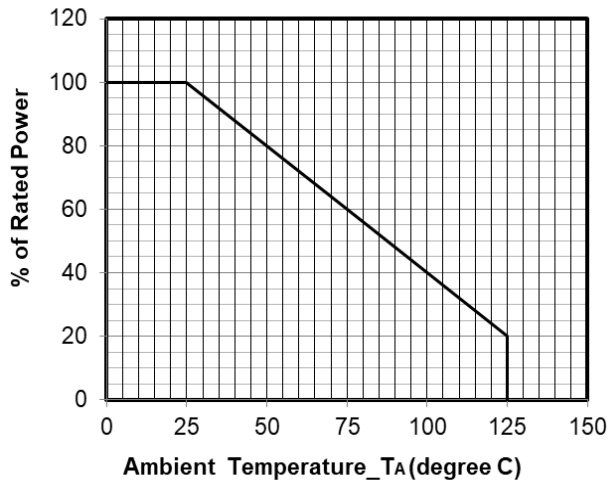

Power Derating Curve

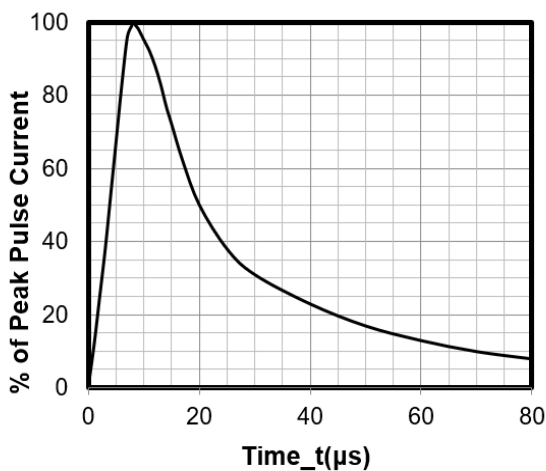

8 X 20μs Pulse Waveform

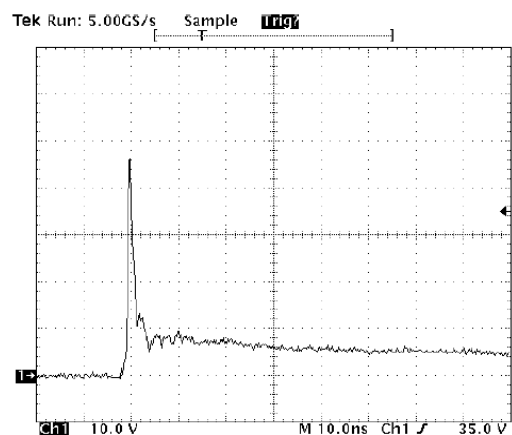

Note: Data is taken with a 10x attenuator

**ESD Clamping Voltage
8 kV Contact per IEC61000-4-2**

SOD-323 Package Outline Drawing

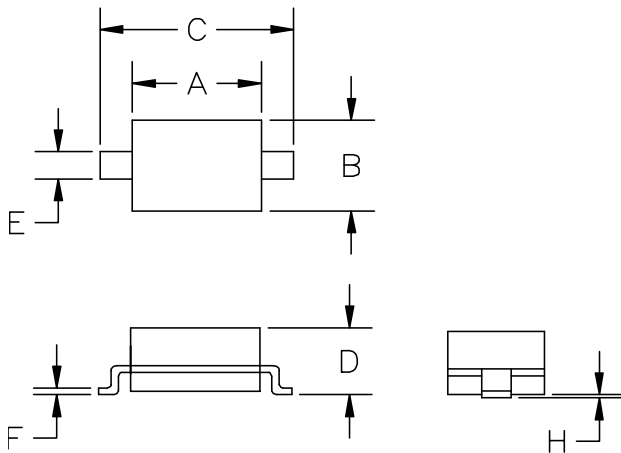

SYM	DIMENSIONS			
	MILLIMETERS		INCHES	
	MIN	MAX	MIN	MAX
A	1.50	1.80	0.060	0.071
B	1.20	1.40	0.045	0.054
C	2.30	2.70	0.090	0.107
D	-	1.10	-	0.043
E	0.30	0.40	0.012	0.016
F	0.10	0.25	0.004	0.010
H	-	0.10	-	0.004

Suggested Land Pattern

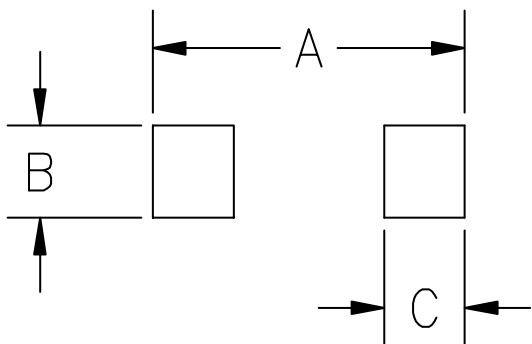

SYM	DIMENSIONS	
	MILLIMETERS	INCHES
A	3.15	0.120
B	0.80	0.031
C	0.80	0.031

Contact Information

Changzhou D-first Electronics CO.,Ltd.

www.first-electronic.com

Email: xhf@first-electronic.cn

Phone: +86 (0519) 8817 1671